



**JOYLU**<sup>®</sup>

JOYLU SPORT

**CATÁLOGO  
STOCK**



CATÁLOGO ONLINE

**WWW.JOYLU.COM**





# PERSONALIZA

Ante la demanda cada vez mayor por el público en general de artículos fabricados en exclusiva para algún tipo de celebración deportiva, evento, etc... les ofrecemos el servicio de fabricación a medida

El tiempo de servicio oscila entre los 7 y 15 días dependiendo de la complejidad del modelo

La cantidad mínima de fabricación es de 50 prendas por modelo, siendo por talla múltiplo de 10



# JOYLU<sup>®</sup>

JOYLU SPORT

PUEDE REALIZAR  
SU CONFIGURACIÓN EN  
**"DISEÑA TU PRENDA"**

DENTRO DE NUESTRA WEB

[www.joylu.com](http://www.joylu.com)



# ELIGE LOS COLORES

en las prendas  
que contengan  
**este sello**



CREA TU DISEÑO





# SUDADERA BÁSICA BASIC Ref. 109

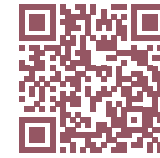

## DESCRIPCIÓN

Sudadera de corte clásico de cuello redondo, con doble pespunte en cuello.

## TEJIDO

Felpa lisa perchada

## COMPOSICIÓN

70% algodón 30% poliéster  
260 gr/m<sup>2</sup>

## OPCIONES DE PERSONALIZACIÓN

- Bordado
- Serigrafía
- Vinilo termoadhesivo

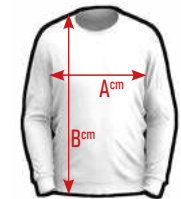

MEDIDAS APROXIMADAS



	XS	S	M	L	XL	XXL
A	49	53	57	61	65	69
B	65	71	74	77	80	83

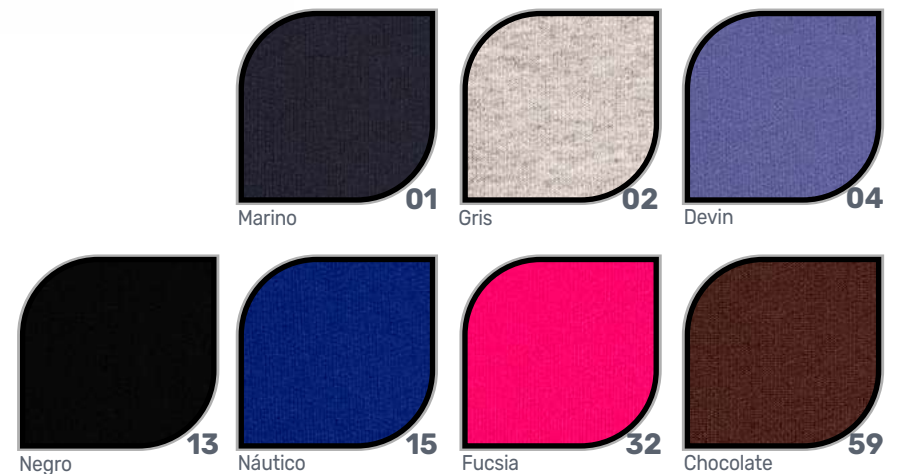



Marino

Gris

# SUDADERA BÁSICA CÓRDOBA

## Ref. 001



Blanco

Rojo



Negro

Náutico

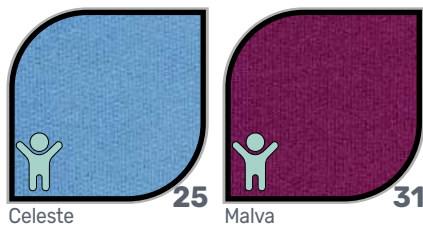

Celeste

Malva

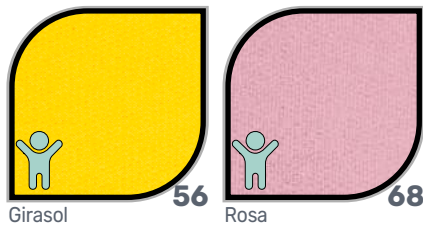

Girasol

Rosa

### DESCRIPCIÓN

Sudadera de corte clásico de cuello redondo, con doble pespunte en cuello, puños y cintura.

### TEJIDO

Felpa lisa perchada

### COMPOSICIÓN

50% algodón 50% poliéster  
285 gr/m<sup>2</sup>

### OPCIONES DE PERSONALIZACIÓN

- Bordado
- Serigrafía
- Vinilo termoadhesivo



	2/3	4/5	6/7	8/9	10/11
A	33	36	39	42	45
B	42	46	50	54	58

	XS	S	M	L	XL	XXL	3XL
A	49	53	57	61	65	69	73
B	65	68	71	74	77	80	83

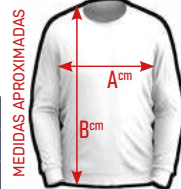

MEDIDAS APROXIMADAS

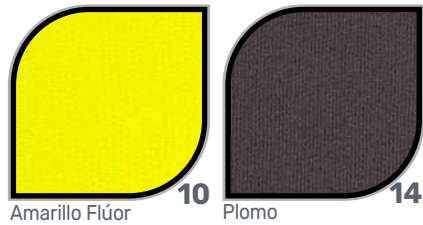

Amarillo Flúor

Plomo



Rioja

Verde botella





# SUDADERA BÁSICA SIN CANALÉ

Ref. 002



## DESCRIPCIÓN

Sudadera de corte clásico cuello redondo, doble respunte en cuello. Cintura y puños sin canalé.

## TEJIDO

Felpa lisa perchada

## COMPOSICIÓN

50% algodón 50% poliéster  
285 gr/m<sup>2</sup>

## OPCIONES DE PERSONALIZACIÓN

- ▶ Bordado
- ▶ Serigrafía
- ▶ Vinilo termoadhesivo

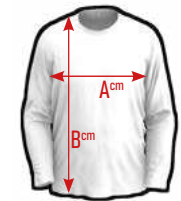

MEIDAS APROXIMADAS



	XS	S	M	L	XL	XXL
A	49	53	57	61	65	69
B	67	70	73	76	79	82



Marino

01

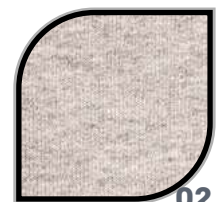

Gris

02

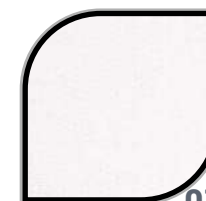

Blanco

03



Rojo

05

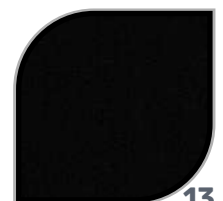

Negro

13



# SUDADERA BÁSICA MIAMI

## Ref. 037



### DESCRIPCIÓN

Sudadera de corte ranglan de cuello redondo, con doble pespunte en cuello, puños y cintura.

### TEJIDO

Felpa lisa perchada

### COMPOSICIÓN

50% algodón 50% poliéster  
285 gr/m<sup>2</sup>

### OPCIONES DE PERSONALIZACIÓN

- Bordado
- Serigrafía
- Vinilo termoadhesivo

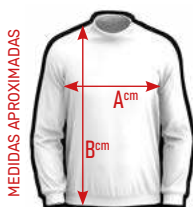

	XS	S	M	L	XL	XXL
A	49	53	57	61	65	69
B	65	68	71	74	77	80



# SUDADERA ORIGINAL ORLANDO

## Ref. 040



### DESCRIPCIÓN

Sudadera de corte ranglan de cuello alto con cremallera, con doble pespunte en puños y cintura.

### TEJIDO

Felpa lisa perchada

### COMPOSICIÓN

50% algodón 50% poliéster  
285 gr/m<sup>2</sup>

### OPCIONES DE PERSONALIZACIÓN

- Bordado
- Serigrafía
- Vinilo termoadhesivo

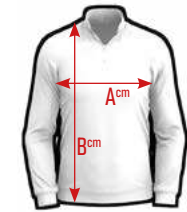

MEDIDAS APROXIMADAS

	XS	S	M	L	XL	XXL
A	49	53	57	61	65	69
B	65	68	71	74	77	80



Marino 01

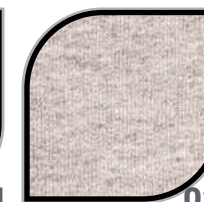

Gris 02

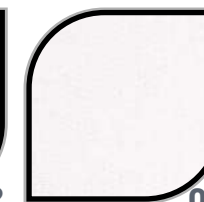

Blanco 03

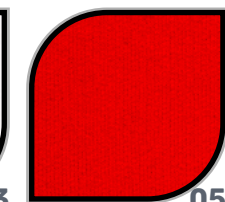

Rojo 05



Negro 13



Rojo/Negro 39



Gris/Negro 45



Negro/Billar AC



Marino/Rioja BF



# SUDADERA ORIGINAL SEVILLA

## Ref. 202



### DESCRIPCIÓN

Sudadera corte clásico de cuello alto con cremallera, con doble pespunte en puños y cintura.

### TEJIDO

Felpa lisa perchada

### COMPOSICIÓN

50% algodón 50% poliéster  
285 gr/m<sup>2</sup>

### OPCIONES DE PERSONALIZACIÓN

- Bordado
- Serigrafía
- Vinilo termoadhesivo



Marino

01

	6/7	8/9	10/11
A	39	42	45
B	50	54	58

	XS	S	M	L	XL	XXL
A	49	53	57	61	65	69
B	65	68	71	74	77	80



MEDIDAS APROXIMADAS

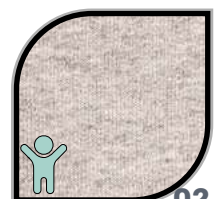

Gris

02



Blanco

03



Rojo

05



Negro

13

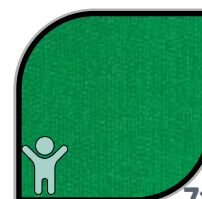

Verde Billar

71

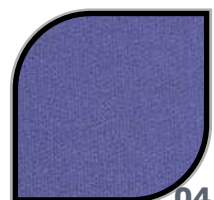

Devín

04

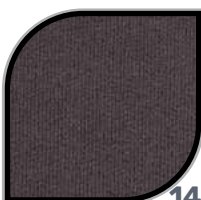

Plomo

14



Náutico

15



Rioja

16



Verde botella

63





# SUDADERA CAPUCHA BASIC



Ref. 115  
BOLSILLO CANGURO

## DESCRIPCIÓN

Sudadera corte clásico con capucha doble, bolsillo canguro a tono.

## TEJIDO

Felpa lisa perchada

## COMPOSICIÓN

70% algodón 30% poliéster  
260 gr/m<sup>2</sup>

## OPCIONES DE PERSONALIZACIÓN

- Bordado
- Serigrafía
- Vinilo termoadhesivo



	XS	S	M	L	XL	XXL
A	49	53	57	61	65	69
B	65	71	74	77	80	83



MEDIDAS APROXIMADAS



Marino

01

Gris

02



Negro

13

Náutico

15



Negro/Malva

18

Náutico/Girasol

20



Gris/Malva

26

Blanco/Náutico

38



Marino/Rojo

40

Rojo/Blanco

54



Rosa/Azulón Vigoré

BY

Fucsia/Negro

CL



UNISEX INVIERNO FELPA

10 JOYLU



Blanco/Negro 09

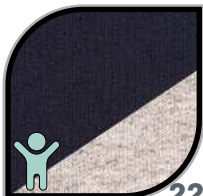

Marino/Gris 22



Rojo/Negro 39



Gris/Negro 45

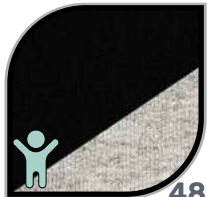

Negro/Gris 48



Rosa/Malva 49



Malva/Blanco 50

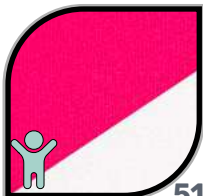

Fucsia/Blanco 51



Náutico/Blanco 55

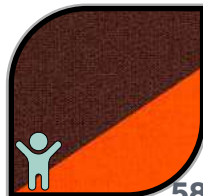

Chocolate/Naranja 58

# SUDADERA CAPUCHA MADRID Ref. 009



**BOLSILLO CANGURO**

## DESCRIPCIÓN

Sudadera corte clásico con capucha doble, bolsillo canguro a tono, con doble pespunte en puños y cintura.

## TEJIDO

Felpa lisa perchada

## COMPOSICIÓN

50% algodón 50% poliéster  
285 gr/m<sup>2</sup>

## OPCIONES DE PERSONALIZACIÓN

- ▶ Bordado
- ▶ Serigrafía
- ▶ Vinilo termoadhesivo



	6/7	8/9	10/11
A	39	42	45
B	52	54	58



	XS	S	M	L	XL	XXL
A	49	53	57	61	65	69
B	65	68	71	74	77	80

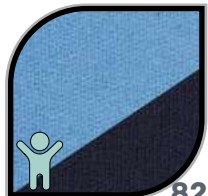

Celeste/Marino 82

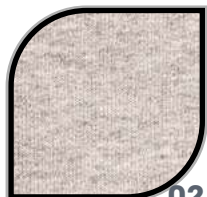

Gris 02



Negro 13





# SUDADERA CAPUCHA MURCIA Ref. 005



## DESCRIPCIÓN

Sudadera corte clásico con capucha simple con doble pespunte en puños y cintura.

## TEJIDO

Felpa lisa perchada

## COMPOSICIÓN

50% algodón 50% poliéster  
285 gr/m<sup>2</sup>

## OPCIONES DE PERSONALIZACIÓN

- Bordado
- Serigrafía
- Vinilo termoadhesivo



	XS	S	M	L	XL	XXL
A	49	53	57	61	65	69
B	65	68	71	74	77	80



Marino

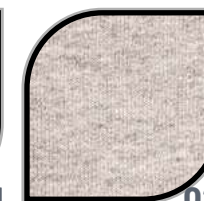

Gris

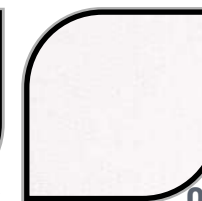

Blanco

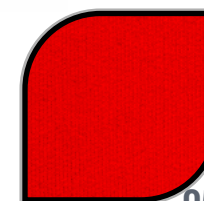

Rojo



Negro

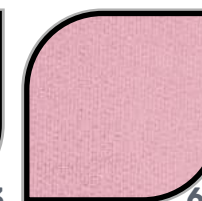

Rosa





Marino

01

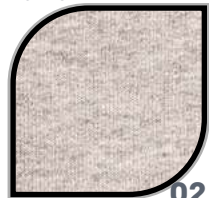

Gris

02

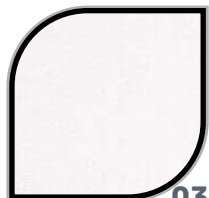

Blanco

03

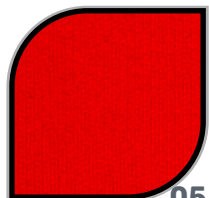

Rojo

05



Negro

13



Marino/Celeste

AR



Gris/Plomo

AY



Blanco/Rojo

36



Rojo/Marino

AJ

# SUDADERA CAPUCHA CHICAGO Ref. 038

**BOLSILLO CANGURO**



## DESCRIPCIÓN

Sudadera de corte ranglan con capucha doble y bolsillo canguro con doble pespunte en puños y cintura.

## TEJIDO

Felpa lisa perchada

## COMPOSICIÓN

50% algodón 50% poliéster  
285 gr/m<sup>2</sup>

## OPCIONES DE PERSONALIZACIÓN

- ▶ Bordado
- ▶ Serigrafía
- ▶ Vinilo termoadhesivo



MEIDAS APROXIMADAS



	XS	S	M	L	XL	XXL
A	49	53	57	61	65	69
B	65	68	71	74	77	80



UNISEX INVIERNO FELPA



# CHAQUETA CUELLO ALTO HUESCA

Ref. 031

BOLSILLO FRANCÉS



## DESCRIPCIÓN

Chaqueta de corte clásico de cuello alto y bolsillo francés. Puños con canalé y cintura sin canalé.

## TEJIDO

Felpa lisa perchada

## COMPOSICIÓN

50% algodón 50% poliéster  
285 gr/m<sup>2</sup>

## OPCIONES DE PERSONALIZACIÓN

- Bordado
- Serigrafía
- Vinilo termoadhesivo

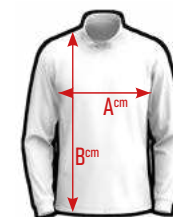

MEDIDAS APROXIMADAS



	XS	S	M	L	XL	XXL
A	49	53	57	61	65	69
B	67	70	73	76	79	82



Marino

01

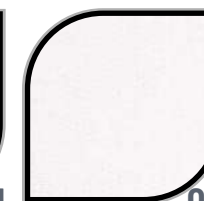

Blanco

03



Negro

13

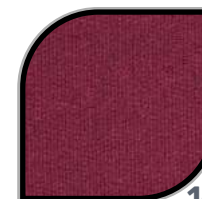

Rioja

16

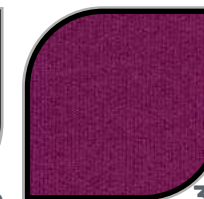

Malva

31

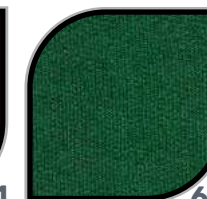

Verde botella

63





# CHAQUETA BÓMBER

## Ref. 030

BOLSILLO FRANCÉS



### DESCRIPCIÓN

Chaqueta de corte clásico de cuello alto y bolsillo francés. Cintura y puños con canalé, con doble pespunte.

### TEJIDO

Felpa lisa perchada

### COMPOSICIÓN

50% algodón 50% poliéster  
285 gr/m<sup>2</sup>

### OPCIONES DE PERSONALIZACIÓN

- Bordado
- Serigrafía
- Vinilo termoadhesivo

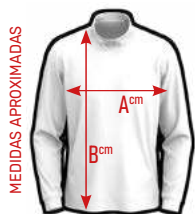

	XS	S	M	L	XL	XXL
A	49	53	57	61	65	69
B	65	68	71	74	77	80

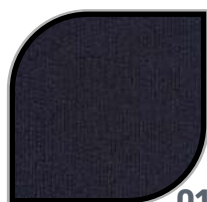

Marino

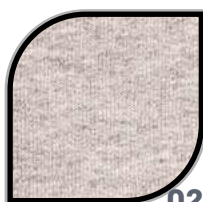

Gris

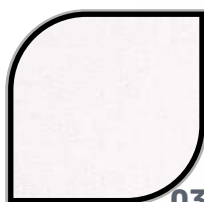

Blanco

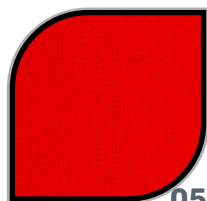

Rojo



Negro

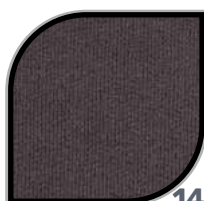

Plomo



Náutico



# CHAQUETA CAPUCHA BOLSILLO CANGURO

## Ref. 034



### DESCRIPCIÓN

Chaqueta de corte clásico con capucha doble y bolsillos canguro, puños y cintura con canalé con doble pespunte.

### TEJIDO

Felpa lisa perchada

### COMPOSICIÓN

50% algodón 50% poliéster  
285 gr/m<sup>2</sup>

### OPCIONES DE PERSONALIZACIÓN

- Bordado
- Serigrafía
- Vinilo termoadhesivo



MEDIDAS APROXIMADAS



	6/7	8/9	10/11
A	39	42	45
B	50	54	58

	XS	S	M	L	XL	XXL
A	49	53	57	61	65	69
B	65	68	71	74	77	80

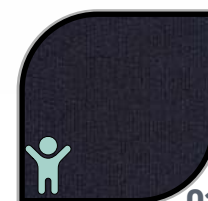

Marino



Rojo

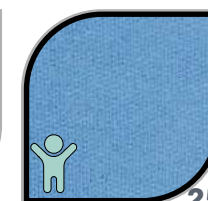

Celeste

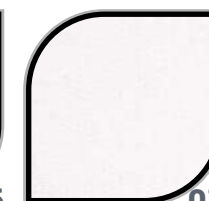

Blanco



Devín



Negro

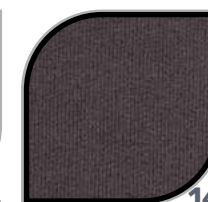

Plomo

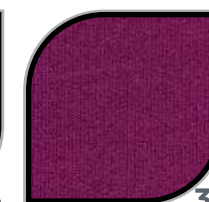

Malva



# CHAQUETA CAPUÇA BOLSILLO FRANCÉS Ref. 035



## DESCRIPCIÓN

Chaqueta de corte clásico con capucha doble y bolsillo francés. Puños y cintura con canalé con doble pesunte.

## TEJIDO

Felpa lisa perchada

## COMPOSICIÓN

50% algodón 50% poliéster  
285 gr/m<sup>2</sup>

## OPCIONES DE PERSONALIZACIÓN

- ▶ Bordado
- ▶ Serigrafía
- ▶ Vinilo termoadhesivo



	XS	S	M	L	XL	XXL
A	49	53	57	61	65	69
B	65	68	71	74	77	80



Marino

01

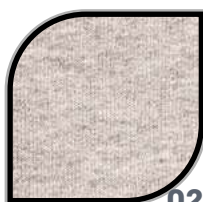

Gris

02

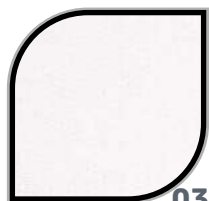

Blanco

03

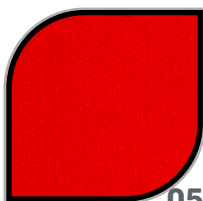

Rojo

05



Negro

13



# CHAQUETA CAPUCHA ATLANTA

Ref. 044

BOLSILLO CANGURO



## DESCRIPCIÓN

Chaqueta de corte ranglan con capucha doble.  
Bolsillo de canguro. Con doble pespunte en  
puños y cintura.

## TEJIDO

Felpa lisa perchada

## COMPOSICIÓN

50% algodón 50% poliéster  
285 gr/m<sup>2</sup>

## OPCIONES DE PERSONALIZACIÓN

- Bordado
- Serigrafía
- Vinilo termoadhesivo



MEDIDAS APROXIMADAS



	XS	S	M	L	XL	XXL
A	49	53	57	61	65	69
B	65	68	71	74	77	80



Marino 01

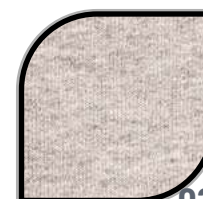

Gris 02



Blanco 03

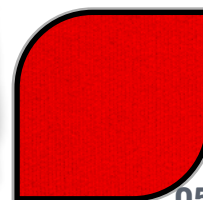

Rojo 05



Negro 13



Gris/Negro 45



Negro/Amarillo Flúor CA

CREATU DISEÑO  
FABRICADO EN ESPAÑA  
MADE IN SPAIN

UNISEX INVIERNO FELPA  
18 JOYLU

# CHAQUETA TRICOLOR CALIFORNIA

Ref. 078

BOLSILLO CANGURO



## DESCRIPCIÓN

Chaqueta de corte ranglan con capucha doble. Bolsillo de canguro. Con doble pespunte en puños y cintura.

## TEJIDO

Felpa lisa perchada

## COMPOSICIÓN

50% algodón 50% poliéster  
285 gr/m<sup>2</sup>

## OPCIONES DE PERSONALIZACIÓN

- Bordado
- Serigrafía
- Vinilo termoadhesivo



	XS	S	M	L	XL	XXL
A	49	53	57	61	65	69
B	65	68	71	74	77	80



Gris 02



Blanco 03



Rojo 05



Negro 13



Náutico 15





# POLO FELPA CÁDIZ Ref. 102



## DESCRIPCIÓN

Polo de felpa de corte clásico. Cuello de tricotosa. Con doble pespunte en puños y cintura.

## TEJIDO

Felpa lisa perchada

## COMPOSICIÓN

50% algodón 50% poliéster  
285 gr/m<sup>2</sup>

## OPCIONES DE PERSONALIZACIÓN

- Bordado
- Serigrafía
- Vinilo termoadhesivo

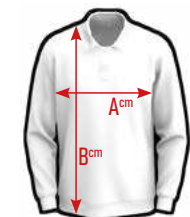

MEDIDAS APROXIMADAS



	XS	S	M	L	XL	XXL
A	49	53	57	61	65	69
B	65	68	71	74	77	80



Marino

01

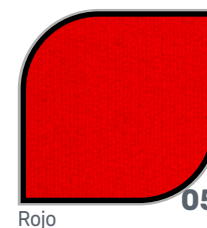

Rojo

05



Náutico

15



Celeste

25



# CHAQUETA WOMAN LISBOA

## Ref. 050

BOLSILLO CANGURO



### DESCRIPCIÓN

Chaqueta de corte ranglan slim fit con capucha doble y bolsillos. Con doble pespunte en puños y cintura.

### TEJIDO

Felpa lisa perchada

### COMPOSICIÓN

50% algodón 50% poliéster  
285 gr/m<sup>2</sup>

### OPCIONES DE PERSONALIZACIÓN

- Bordado
- Serigrafía
- Vinilo termoadhesivo



	XXS	XS	S	M	L	XL
A	38	42	46	50	55	60
B	57	59,5	62	64,5	67	69,5

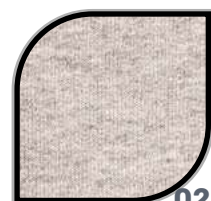

Gris



Negro



Celeste

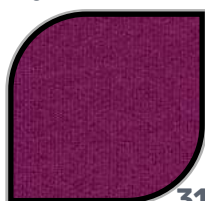

Malva

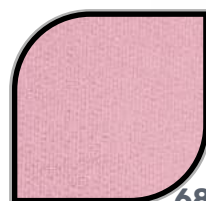

Rosa





# PANTALÓN SPORT Ref. 003

BOLSILLO FRANCÉS



## DESCRIPCIÓN

Pantalón de felpa de corte deportivo con bolsillos laterales. Cintura elástica con cordón. Bajo con puño.

## TEJIDO

Felpa lisa perchada

## COMPOSICIÓN

50% algodón 50% poliéster  
285 gr/m<sup>2</sup>

## OPCIONES DE PERSONALIZACIÓN

- Bordado
- Serigrafía
- Vinilo termoadhesivo



MEDIDAS APROXIMADAS

	2/3	4/5	6/7	8/9	10/11
A	24	25	26	27	28
B	62	69	76	83	90

	XS	S	M	L	XL	XXL
A	30	32	34	36	38	40
B	98	101	104	107	110	113

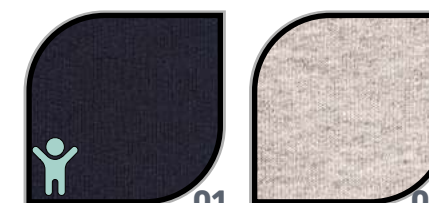

Marino

01

Gris

02



Blanco

03

Negro

13





# PANTALÓN CLASSIC Ref. 004

BOLSILLO FRANCÉS



## DESCRIPCIÓN

Pantalón de felpa de corte clásico con bolsillos laterales. Cintura elástica con cordón. Bajo con dobladillo.

## TEJIDO

Felpa lisa perchada

## COMPOSICIÓN

50% algodón 50% poliéster  
285 gr/m<sup>2</sup>

## OPCIONES DE PERSONALIZACIÓN

- Bordado
- Serigrafía
- Vinilo termoadhesivo



	2/3	4/5	6/7	8/9	10/11
A	24	25	26	27	28
B	62	69	76	83	90

	XS	S	M	L	XL	XXL
A	30	32	34	36	38	40
B	98	101	104	107	110	113





# BERMUDA FELPA VERANO

## Ref. 059

BOLSILLO FRANCÉS

### DESCRIPCIÓN

Bermuda de felpa de corte deportivo con bolsillos laterales. Cintura elástica con cordón.

### TEJIDO

Felpa lisa sin perchar

### COMPOSICIÓN

50% algodón 50% poliéster  
285 gr/m<sup>2</sup>

### OPCIONES DE PERSONALIZACIÓN

- Bordado
- Serigrafía
- Vinilo termoadhesivo



MEDIDAS APROXIMADAS



	2/3	4/5	6/7	8/9	10/11
A	24	25	26	27	28
B	28	31	34	37	40

	XS	S	M	L	XL	XXL
A	30	32	34	36	38	40
B	41	43	45	47	49	51



Marino

01



Negro

13



CREATU DISEÑO



FABRICADO EN ESPAÑA  
MADE IN SPAIN

# CAMISETA MANGA CORTA

## 50% alg./pol.

### Ref. 124



#### DESCRIPCIÓN

Camiseta básica de cuello redondo y manga corta. Hombros avanzados. Doble pespunte en cuello, bajo y hombros.

#### TEJIDO

Pulto liso

#### COMPOSICIÓN

50% algodón 50% poliéster  
160 gr/m<sup>2</sup>

#### OPCIONES DE PERSONALIZACIÓN

- Bordado
- Serigrafía
- Vinilo termoadhesivo

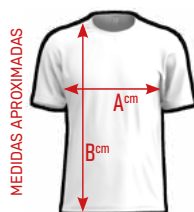

	XS	S	M	L	XL	XXL	3XL
A	48	50	53	56	59	62	65
B	67	70	72	74	76	78	80



# CAMISETA MANGA LARGA

50% alg./pol.  
Ref. 125



## DESCRIPCIÓN

Camiseta de cuello redondo. Hombros avanzados.  
Dobles pespuntos en cuello, bajo, mangas y hombros.

## TEJIDO

Pulto liso

## COMPOSICIÓN

50% algodón 50% poliéster  
160 gr/m<sup>2</sup>

## OPCIONES DE PERSONALIZACIÓN

- Bordado
- Serigrafía
- Vinilo termoadhesivo

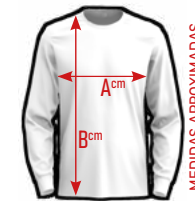

MEDIDAS APROXIMADAS



	XS	S	M	L	XL	XXL	3XL
A	48	50	53	56	59	62	65
B	67	70	72	74	76	78	80



# POLO MANGA CORTA

## 50% alg./pol.

### Ref. 126



#### DESCRIPCIÓN

Polo de manga corta. Elástico en manga. Hombros avanzados. Dobles pespuntos en bajo y hombros. Dos botones.

#### TEJIDO

Piqué

#### COMPOSICIÓN

50% algodón 50% poliéster  
210 gr/m<sup>2</sup>

#### OPCIONES DE PERSONALIZACIÓN

- Bordado
- Serigrafía
- Vinilo termoadhesivo

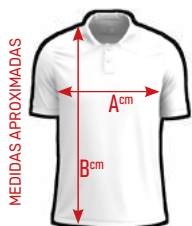

	XS	S	M	L	XL	XXL	3XL
A	48	50	53	56	59	62	65
B	67	70	72	74	76	78	80

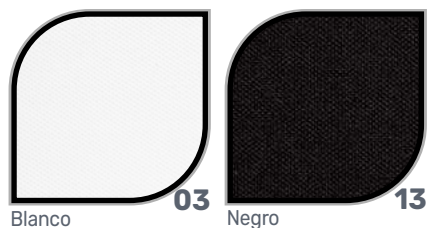
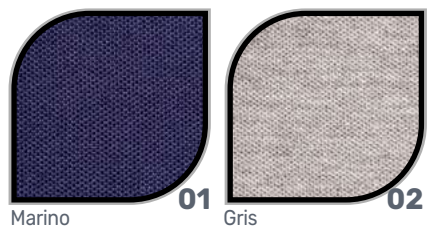



# POLO MANGA LARGA

**50% alg./pol.**  
**Ref. 127**



## DESCRIPCIÓN

Polo de manga larga. Puño en manga. Hombros avanzados. Dobles pespuntos en bajo y hombros. Dos botones.

## TEJIDO

Piqué

## COMPOSICIÓN

50% algodón 50% poliéster  
210 gr/m<sup>2</sup>

## OPCIONES DE PERSONALIZACIÓN

- Bordado
- Serigrafía
- Vinilo termoadhesivo

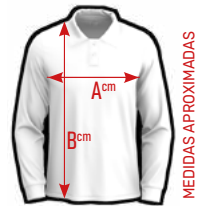

MEDIDAS APROXIMADAS



	XS	S	M	L	XL	XXL	3XL
A	48	50	53	56	59	62	65
B	67	70	72	74	76	78	80

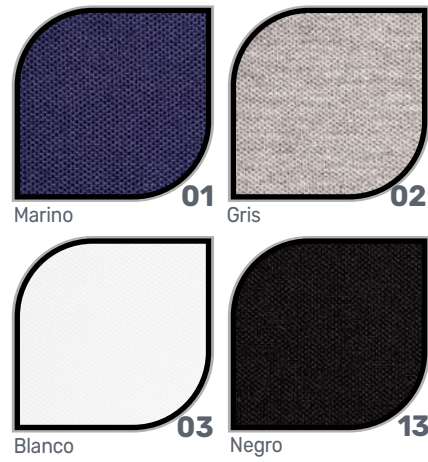

# CAMISETA COMBI CASTELLÓN

Ref. 107



## DESCRIPCIÓN

Camiseta básica de cuello redondo y manga corta. Cuello y elástico de manga en lycra contraste. Hombros avanzados. Doble pespunte en cuello, bajo y hombros.

## TEJIDO

Punto liso de algodón peinado

## COMPOSICIÓN

100% algodón  
170 gr/m<sup>2</sup>

## OPCIONES DE PERSONALIZACIÓN

- Bordado
- Serigrafía
- Vinilo termoadhesivo

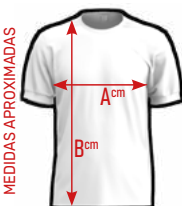

MEDIDAS APROXIMADAS



	XS	S	M	L	XL	XXL
A	48	50	53	56	59	62
B	67	70	72	74	76	78



Blanco/Negro

09



Blanco/Rojo

36



Blanco/Náutico

38



Negro/Pistacho

44



Náutico/Blanco

55





# CAMISETA VALENCIA

## Ref. 106

### DESCRIPCIÓN

Camiseta básica de cuello redondo y manga corta. Cuello en lycra 1x1. Hombros avanzados. Doble pespunte en cuello, bajo y hombros.

### TEJIDO

Punto liso de algodón peinado

### COMPOSICIÓN

100% algodón  
170 gr/m<sup>2</sup>

### OPCIONES DE PERSONALIZACIÓN

- Bordado
- Serigrafía
- Vinilo termoadhesivo



	2/3	4/5	6/7	8/9	10/11
A	32	35	38	41	44
B	42	47	52	57	62

	XS	S	M	L	XL	XXL	3XL
A	48	50	53	56	59	62	65
B	67	70	72	74	76	78	80

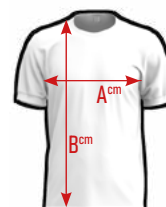

MEDIDAS APROXIMADAS



Pistacho 30

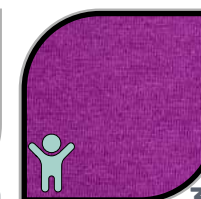

Malva 31

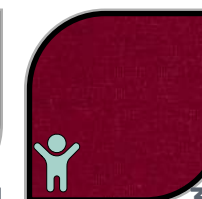

Burdeos 34

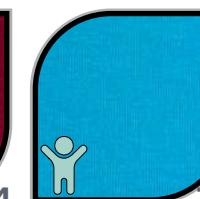

Turquesa 35



Naranja 47

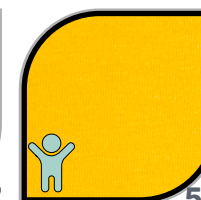

Girasol 56

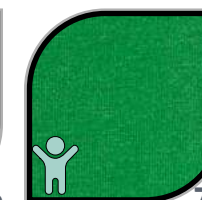

Verde Billar 71

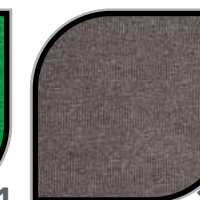

Plomo 14



Marino 01

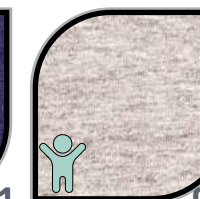

Gris 02

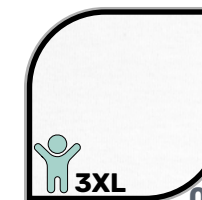

Blanco 03



Rojo 05



Negro 13

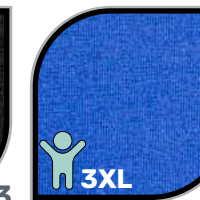

Náutico 15

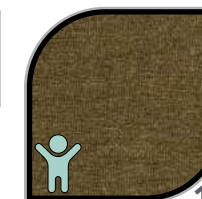

Verde Caza 19

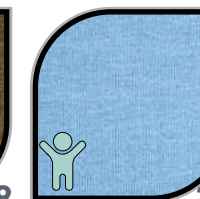

Celeste 25



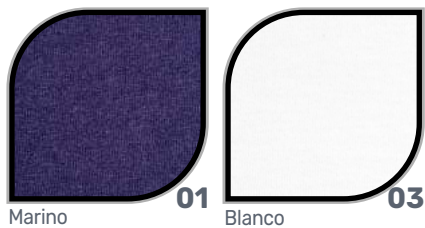

Marino

01

Blanco

03

# POLO PUNTO LISO

## ALMERÍA

### Ref. 108



Negro

13

Náutico

15



Blanco/Rojo

36

Blanco/Marino

37



Rojo/Negro

39

Marino/Rojo

40



Negro/Pistacho

44

Gris/Negro

45



Naranja/Negro

53



Chocolate/Tierra

57

Náutico/Marino

61



Pistacho/Negro

80



Celeste/Marino

82

### DESCRIPCIÓN

Polo de manga corta. Cuello de tricotosa y elástico en manga a contraste. Hombros avanzados. Dobles pespuntos en bajo y hombros. Dos botones.

### TEJIDO

Punto liso de algodón peinado

### COMPOSICIÓN

100% algodón  
170 gr/m<sup>2</sup>

### OPCIONES DE PERSONALIZACIÓN

- ▶ Bordado
- ▶ Serigrafía
- ▶ Vinilo termoadhesivo



	XS	S	M	L	XL	XXL
A	48	50	53	56	59	62
B	65	68	70	72	74	76

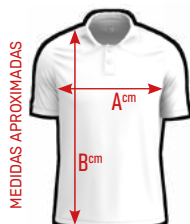

MEDIDAS APROXIMADAS





# POLO MÁLAGA

## Ref. 020

### DESCRIPCIÓN

Polo de manga corta. Cuello de tricotosa y elástico en manga. Hombros avanzados. Dobles pespuntos en bajo y hombros. Dos botones.

### TEJIDO

Piqué de algodón peinado

### COMPOSICIÓN

100% algodón  
220 gr/m<sup>2</sup>

### OPCIONES DE PERSONALIZACIÓN

- Bordado
- Serigrafía
- Vinilo termoadhesivo



	2/3	4/5	6/7	8/9	10/11
A	32	35	38	41	44
B	42	47	52	57	62

	XS	S	M	L	XL	XXL	3XL
A	48	50	53	56	59	62	65
B	65	68	70	72	74	76	79

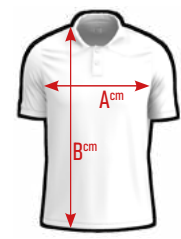

MEDIDAS APROXIMADAS

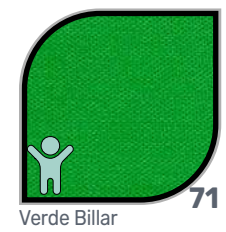
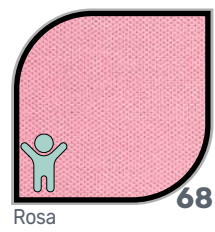
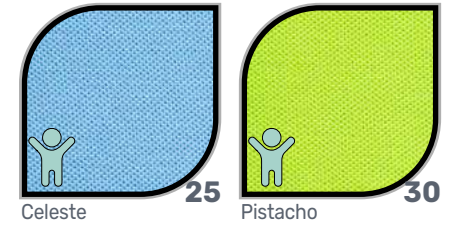

# POLO ESPAÑA Ref. 120



## DESCRIPCIÓN

Polo de manga corta. Cuello de tricotosa y elástico en manga con bandera de "España" en filo. Hombros avanzados. Dobles pespuntos en bajo y hombros. Dos botones.

## TEJIDO

Piqué de algodón peinado

## COMPOSICIÓN

100% algodón  
220 gr/m<sup>2</sup>

## OPCIONES DE PERSONALIZACIÓN

- Bordado
- Serigrafía
- Vinilo termoadhesivo



	4/5	6/7	8/9	10/11
A	35	38	41	44
B	47	52	57	62

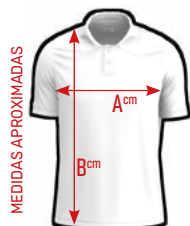

MEDIDAS APROXIMADAS

	XS	S	M	L	XL	XXL
A	48	50	53	56	59	62
B	65	68	70	72	74	76

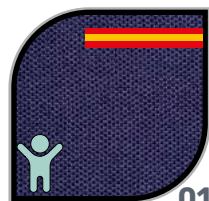

Marino

01



Blanco

03



Rojo

05



Náutico

15



Gris

02



Negro

13



Verde Caza

19



Chocolate

59



# CAMISETA MICROPOLIÉSTER OLIMPO Ref. 181



## DESCRIPCIÓN

Camiseta técnica de cuello redondo y manga corta tipo ranglan. Costuras laterales para una mejor adaptación al cuerpo. Ribete en cuello en tejido lycra 1x1. Dobles pespuntos en bajo, mangas y hombros.

## TEJIDO

Micropoliéster

## COMPOSICIÓN

100% poliéster  
130 gr/m<sup>2</sup>

## OPCIONES DE PERSONALIZACIÓN

- Bordado
- Serigrafía
- Vinilo termoadhesivo
- Sublimación

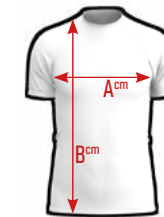

MEDIDAS APROXIMADAS

	4/5	6/7	8/9	10/11
A	35	38	41	44
B	47	52	57	62

	XS	S	M	L	XL	XXL	3XL
A	48	50	53	56	59	62	65
B	67	70	72	74	76	78	80

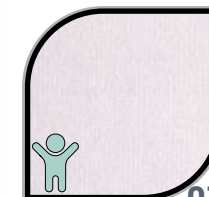

Blanco

03



Marino

01



Rojo

05



Amarillo Flúor

10



Negro

13



Náutico

15



# PANTALÓN MICROPOLIÉSTER

## MARTE

### Ref. 171



#### DESCRIPCIÓN

Pantalón corto con cintura elástica y cordón para un mejor ajuste.

#### TEJIDO

Micropoliéster

#### COMPOSICIÓN

100% poliéster  
130 gr/m<sup>2</sup>

#### OPCIONES DE PERSONALIZACIÓN

- Bordado
- Serigrafía
- Vinilo termoadhesivo
- Sublimación



	4/5	6/7	8/9	10/11
A	22.5	24.5	26.5	28.5
B	27	29	31	33

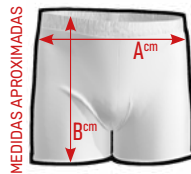

	XS	S	M	L	XL	XXL
A	31	33	35	37	39	41
B	35	37	38	39	40	41





# CHALECO ACOLCHADO Ref. 319

## DESCRIPCIÓN

Chaleco ligero acolchado con cremalleras inversas delante y bolsillos con tirador pulgar. Tratamiento repelente al agua. Diseño acolchado 5,5 cm. en horizontal.

## COMPOSICIÓN

Exterior: 100% poliamida  
Relleno: Crush padding 100% poliéster, 60 gr

## OPCIONES DE PERSONALIZACIÓN

- Bordado
- Serigrafía
- Vinilo termoadhesivo



	XS	S	M	L	XL	XXL
A	51	53,5	56	58,5	61	63,5
B	65	67	69	71	73	75



Marino

01



Gris

02



Negro

13



Verde Caza

19

# CHAQUETA ACOLCHADA

## Ref. 318



### DESCRIPCIÓN

Chaqueta ligera acolchada con cremalleras inversas delante y bolsillos con tirador pulgar. Tratamiento repelente al agua. Diseño acolchado 5,5 cm en horizontal.

### COMPOSICIÓN

Exterior: 100% poliamida

Relleno: Crush padding 100% poliéster, 60 gr

### OPCIONES DE PERSONALIZACIÓN

- Bordado
- Serigrafía
- Vinilo termoadhesivo



	XS	S	M	L	XL	XXL
A	51,5	54	56,5	59	61,5	64
B	70	72	74	76	78	80



Marino

01



Gris

02



Negro

13



Verde Caza

19





# PARKA 3/4 ACOLCHADA Ref. 320

## DESCRIPCIÓN

Parka 3/4 ligera acolchada con capucha y cremallera inversa delante con doble tirador para apertura de abajo/arriba y bolsillos con cremallera. Tratamiento repelente al agua. Diseño acolchado 5,5 cm en horizontal.

## COMPOSICIÓN

Exterior: 100% poliamida  
Relleno: Crush padding 100% poliéster, 60 gr

## OPCIONES DE PERSONALIZACIÓN

- Bordado
- Serigrafía
- Vinilo termoadhesivo

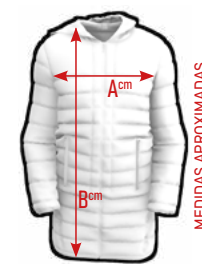

MEDIDAS APROXIMADAS



	XS	S	M	L	XL	XXL
A	51,5	54	56,5	59	61,5	64
B	84	86	88	90	91	94



Negro



# CHAQUETA SOFTSHELL BASIC

Ref. 308



## DESCRIPCIÓN

Chaqueta con tecnología softshell triple capa, terminación waterproof. Puños ajustables. Bajo ajustable con tensores. Bolsillos laterales con cierre y cremalleras a contraste.

## COMPOSICIÓN

97% poliamida 3% spandex  
285 gr/m<sup>2</sup>

## OPCIONES DE PERSONALIZACIÓN

- Bordado
- Serigrafía
- Vinilo termoadhesivo

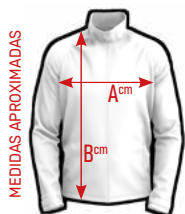

	XS	S	M	L	XL	XXL	3XL
A	47	50	53	57	61	65	69
B	68	69	70	71	72	73	74



Marino

01



Rojo

05



Verde

08



Negro

13

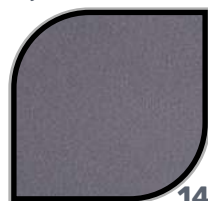

Plomo

14



Náutico

15



# CHALECO SOFTSHELL Ref. 315



## DESCRIPCIÓN

Chaleco con tecnología softshell triple capa, terminación waterproof. Bajo ajustable con tensores. Bolsillos laterales y bolsillo en pecho con cremallera.

## COMPOSICIÓN

97% poliamida 3% spandex  
330 gr/m<sup>2</sup>

## OPCIONES DE PERSONALIZACIÓN

- Bordado
- Serigrafía
- Vinilo termoadhesivo

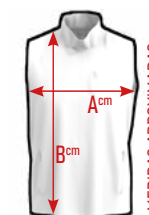

MEDIDAS APROXIMADAS



	XS	S	M	L	XL	XXL
A	51	53,5	56	58,5	61	63,5
B	65	67	69	71	73	75



Marino

01



Negro

13



Plomo

14



Verde Caza

19



Chocolate

59



# CHAQUETA SOFTSHELL Ref. 314

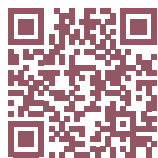

## DESCRIPCIÓN

Chaqueta con tecnología softshell triple capa, terminación waterproof e interior con rejilla transpirable. Puños ajustables. Bajo ajustable con tensores. Bolsillos laterales y bolsillo en pecho con cierre.

## COMPOSICIÓN

97% poliamida 3% spandex  
330 gr/m<sup>2</sup>

## OPCIONES DE PERSONALIZACIÓN

- ▶ Bordado
- ▶ Serigrafía
- ▶ Vinilo termoadhesivo

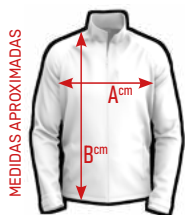

	XS	S	M	L	XL	XXL
A	51,5	54	56,5	59	61,5	64
B	70	72	74	76	78	80



Marino

01



Negro

13

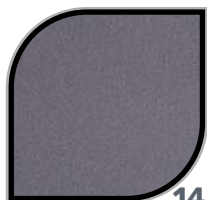

Plomo

14

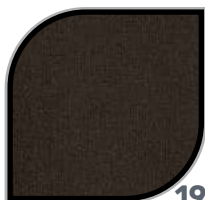

Verde Caza

19



Chocolate





# CHALECO POLAR Ref. 317



## DESCRIPCIÓN

Chaleco de corte clásico con cuello alto y cremalleras a tono. Bolsillos con cremallera, tratamiento anti-peeling en las dos caras.

## TEJIDO

Felpa polar

## COMPOSICIÓN

100% poliéster  
360 gr/m<sup>2</sup>

## OPCIONES DE PERSONALIZACIÓN

- Bordado
- Serigrafía
- Vinilo termoadhesivo

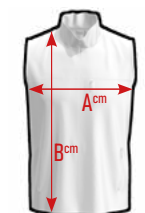

MEDIDAS APROXIMADAS



	XS	S	M	L	XL	XXL
A	51	53,5	56	58,5	61	63,5
B	65	67	69	71	73	75

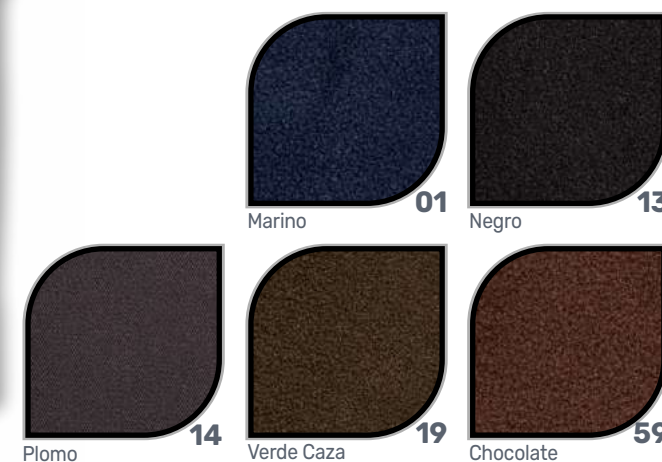

# CHAQUETA POLAR Ref. 316



## DESCRIPCIÓN

Chaqueta de corte clásico con cuello alto y cremalleras a tono. Bolsillos con cremallera, tratamiento antipeeling en las dos caras.

## TEJIDO

Felpa polar

## COMPOSICIÓN

100% poliéster  
360 gr/m<sup>2</sup>

## OPCIONES DE PERSONALIZACIÓN

- Bordado
- Serigrafía
- Vinilo termoadhesivo

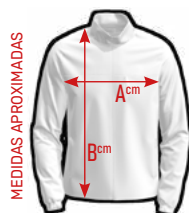

MEDIDAS APROXIMADAS

	XS	S	M	L	XL	XXL
A	51,5	54	56,5	59	61,5	64
B	70	72	74	76	78	80

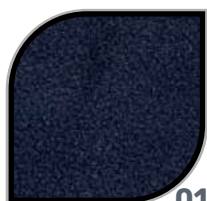

Marino

01



Negro

13

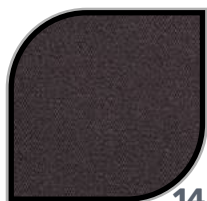

Plomo

14



Verde Caza

19



Chocolate

59



# CHUBASQUERO CICLÓN

Ref. 029



## DESCRIPCIÓN

Chubasquero con tratamiento impermeable de poliuretano. Interior de malla. Tensores en bajo y cremallera central con tapeta. Capucha oculta ajustable con cordón.

## COMPOSICIÓN

Exterior: 100% poliamida  
Malla: 100% poliéster

## OPCIONES DE PERSONALIZACIÓN

- Bordado
- Serigrafía
- Vinilo termoadhesivo

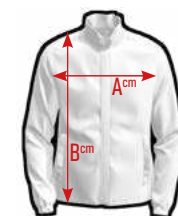

MEDIDAS APROXIMADAS



	XS	S	M	L	XL	XXL
A	54	57	60	63	66	69
B	69	71	73	75	77	79



Marino

01

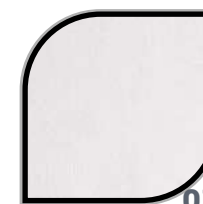

Blanco

03

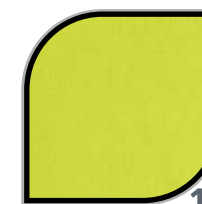

Amarillo Flúor

10



Naranja Flúor

11



Negro

13



Náutico

15

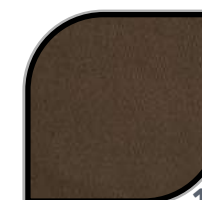

Verde Caza

19



# JERSEY DE VESTIR CUELLO CAJA

## Ref. 151



### TEJIDO

Punto de galga 12

### COMPOSICIÓN

100% algodón

### OPCIONES DE PERSONALIZACIÓN

- Bordado
- Serigrafía
- Vinilo termoadhesivo

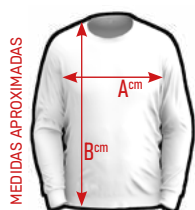

	S	M	L	XL	XXL
A	52	54	56	58	60
B	67	68	69	70	71



Marino

01

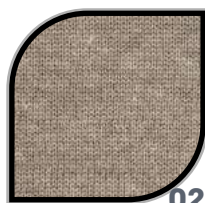

Gris

02

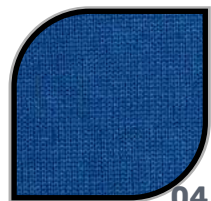

Devín

04

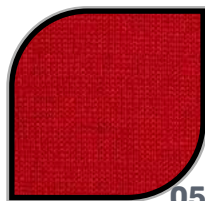

Rojo

05



Verde

08



Burdeos

34



Marengo

74

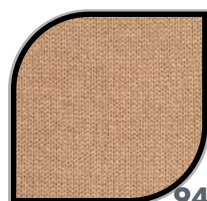

Beige

94





# JERSEY DE VESTIR CUELLO PICO Ref. 150



**TEJIDO**  
Punto de galga 12

**COMPOSICIÓN**  
100% algodón

## OPCIONES DE PERSONALIZACIÓN

- Bordado
- Serigrafía
- Vinilo termoadhesivo



	4/5	6/7	8/9	10/11
A	37	40	43	46
B	49	53	57	61

	XS	S	M	L	XL	XXL
A	49	52	54	56	58	60
B	64	67	68	69	70	71



MEDIDAS APROXIMADAS

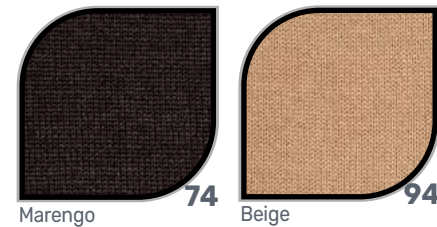
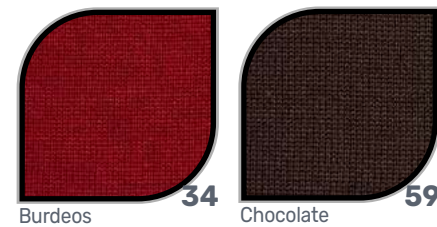
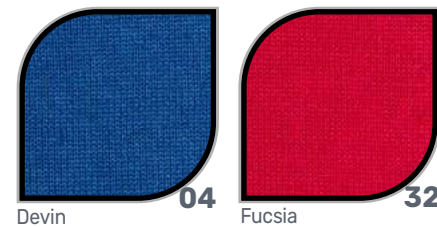
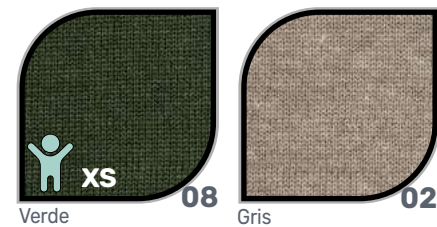



# CHAQUETA DE VESTIR

## Ref. 153



### DESCRIPCIÓN

Chaqueta con cierre de cremallera, cuello alto y dos bolsillos laterales.

### TEJIDO

Pulto de galga 7

### COMPOSICIÓN

100% algodón

### OPCIONES DE PERSONALIZACIÓN

- Bordado
- Serigrafía
- Vinilo termoadhesivo



	S	M	L	XL	XXL
A	52	54	56	58	60
B	67	68	69	70	71

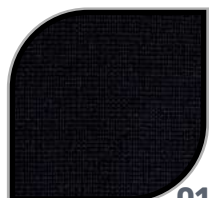

Marino

01

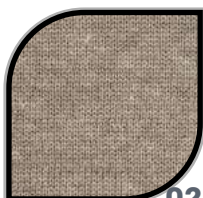

Gris

02

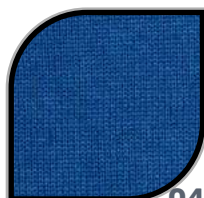

Devín

04

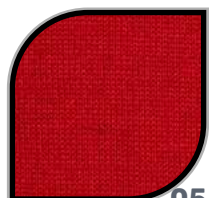

Rojo

05



Verde

08



Burdeos

34



Chocolate

59



Marengo

74

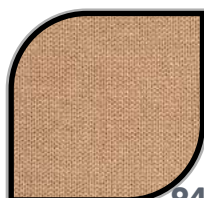

Beige

94

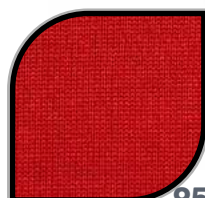

Teja

95





## SOFTSHELL CAPUCHA WOMAN Ref. 307



### DESCRIPCIÓN

Chaqueta con tecnología softshell triple capa, terminación waterproof. Patrón slim fit especial. Capucha desmontable. Interiores en rejilla transpirable. Puños y bajo ajustable. Dos bolsillos laterales más uno en pecho y cremalleras reflectantes..

### COMPOSICIÓN

97% poliamida 3% spandex  
330 gr/m<sup>2</sup>

### OPCIONES DE PERSONALIZACIÓN

- Bordado
- Serigrafía
- Vinilo termoadhesivo



MEIDAS APROXIMADAS



	XS	S	M	L	XL
A	47.5	50	52.5	55	57.5
B	62	63	64	65	65

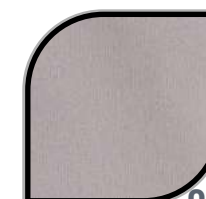

Gris

02

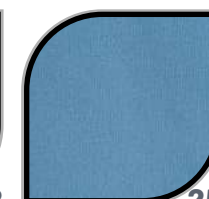

Celeste

25

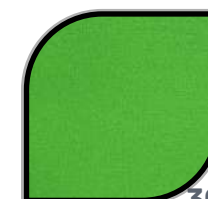

Pistacho

30

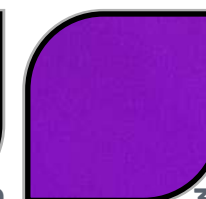

Malva

31

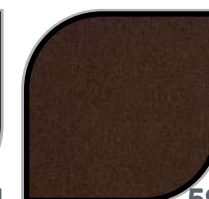

Chocolate

59

# POLO TARIFA

## Ref. 023



### DESCRIPCIÓN

Polo de manga larga. Cuello de tricotosa y elástico en manga. Hombros avanzados. Dobles pespuntos en bajo y hombros. Tres botones.

### TEJIDO

Piqué de algodón peinado

### COMPOSICIÓN

100% algodón  
220 gr/m<sup>2</sup>

### OPCIONES DE PERSONALIZACIÓN

- Bordado
- Serigrafía
- Vinilo termoadhesivo

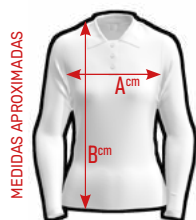

	XS	S	M	L	XL
A	44	46	48	50	52
B	58	60	62	64	66

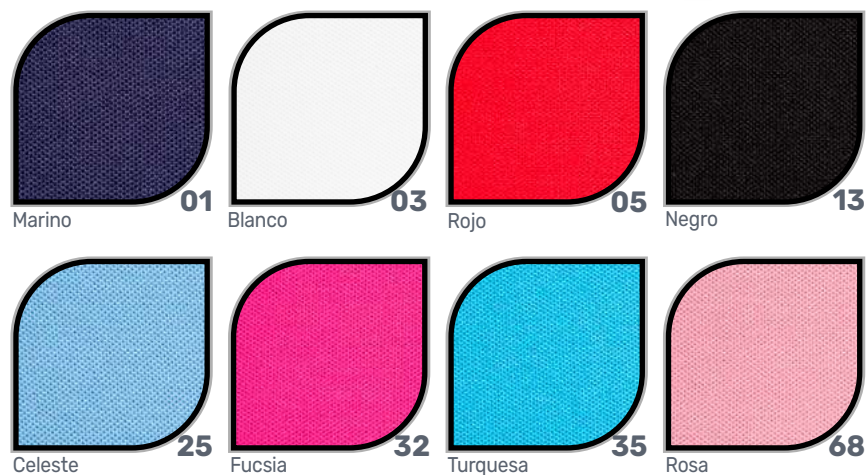

MUJER



## CAMISETA NERJA Ref. 010



### DESCRIPCIÓN

Camiseta básica entallada de cuello redondo y manga corta. Cuello en lycra 1x1. Hombros avanzados. Doble pespunte en cuello, bajos y hombros.

### TEJIDO

Punto liso de algodón peinado

### COMPOSICIÓN

100% algodón  
170 gr/m<sup>2</sup>

### OPCIONES DE PERSONALIZACIÓN

- Bordado
- Serigrafía
- Vinilo termoadhesivo

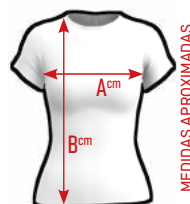

MEDIDAS APROXIMADAS

	XS	S	M	L	XL
A	43	45	47	49	51
B	58	60	62	64	66

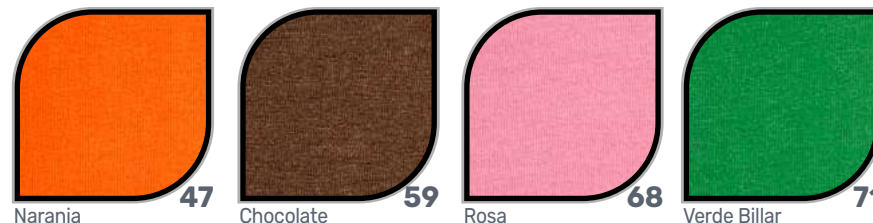
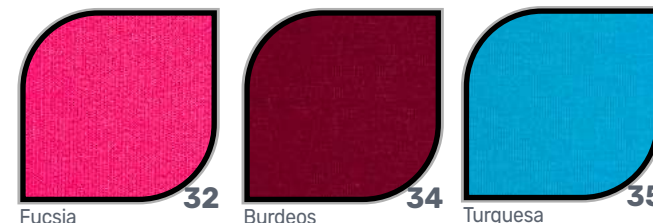
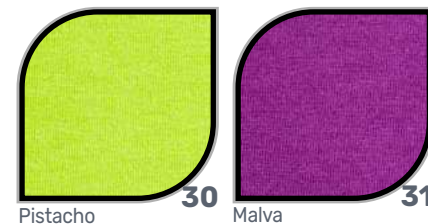
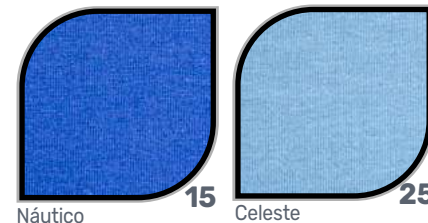
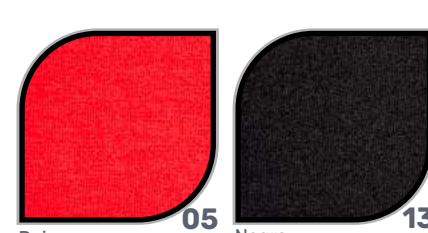

# POLO MOTRIL

## Ref. 041



### DESCRIPCIÓN

Polo de manga corta. Cuello de tricotosa y elástico en manga. Hombros avanzados. Dobles pespuntos en bajo y hombros. Tres botones.

### TEJIDO

Piqué de algodón peinado

### COMPOSICIÓN

100% algodón  
220 gr/m<sup>2</sup>

### OPCIONES DE PERSONALIZACIÓN

- Bordado
- Serigrafía
- Vinilo termoadhesivo

MEDIDAS APROXIMADAS

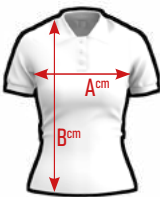

	XS	S	M	L	XL
A	44	46	48	50	52
B	58	60	62	64	66

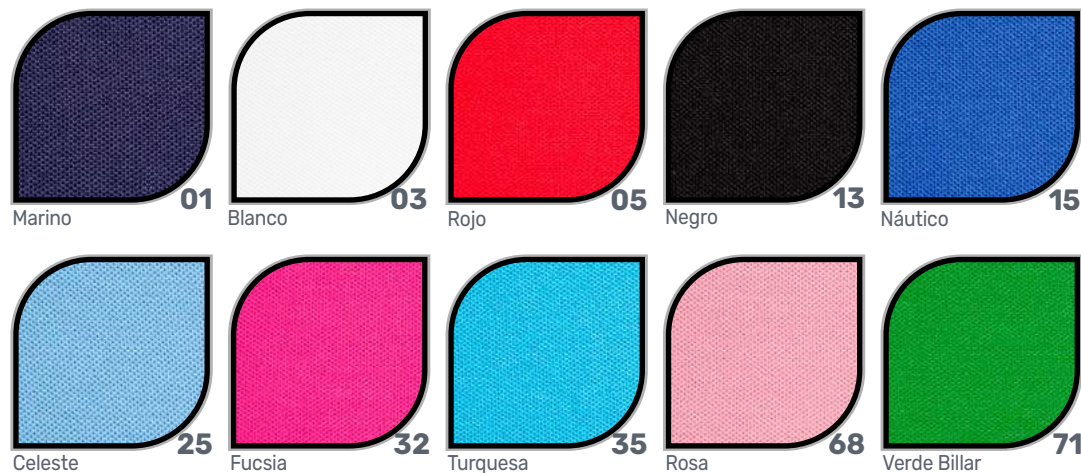

MUJER



# POLO ESPAÑA WOMAN Ref. 121



## DESCRIPCIÓN

Polo de manga corta. Cuello de tricotsa y elástico en manga con bandera de "España" en filo. Hombros avanzados. Dobles pespuntos en bajo y hombros. Tres botones.

## TEJIDO

Piqué de algodón peinado

## COMPOSICIÓN

100% algodón  
220 gr/m<sup>2</sup>

## OPCIONES DE PERSONALIZACIÓN

- Bordado
- Serigrafía
- Vinilo termoadhesivo

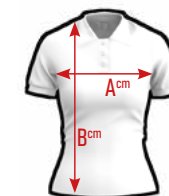

MEDIDAS APROXIMADAS



	XS	S	M	L	XL
A	44	46	48	50	52
B	58	60	62	64	66



Marino

01



Blanco

03



Rojo

05



Náutico

15



Chocolate

59

# LEGGINS CORTO NANTES

Ref. 175



## DESCRIPCIÓN

Leggins corto con cintura elástica y costuras laterales. Diseño anatómico y tejido suave.

## TEJIDO

Punto liso de algodón peinado

## COMPOSICIÓN

92% algodón 8% spandex  
240 gr/m<sup>2</sup>

## OPCIONES DE PERSONALIZACIÓN

- Bordado
- Serigrafía
- Vinilo termoadhesivo



	4/5	6/7	8/9	10/11
A	22	24	26	28
B	22	23	24	25

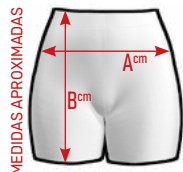

MEDIDAS APROXIMADAS

	XS	S	M	L	XL	XXL
A	30	32	34	36	38	40
B	30	31	32	33	34	35



MUJER



# LEGGINS PIRATA NIZA Ref. 176



## DESCRIPCIÓN

Leggins pirata con cintura elástica y costuras laterales. Diseño anatómico y tejido suave.

## TEJIDO

Punto liso de algodón peinado

## COMPOSICIÓN

92% algodón 8% spandex  
240 gr/m<sup>2</sup>

## OPCIONES DE PERSONALIZACIÓN

- Bordado
- Serigrafía
- Vinilo termoadhesivo

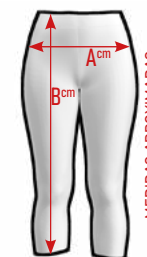

MEDIDAS APROXIMADAS

	4/5	6/7	8/9	10/11
A	22	24	26	28
B	36	43	50	57

	XS	S	M	L	XL	XXL
A	30	32	34	36	38	40
B	65	66	67	68	69	70

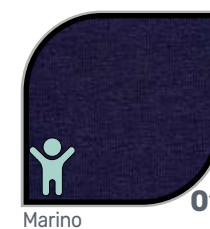

Marino

01

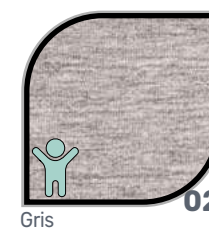

Gris

02



Negro

13

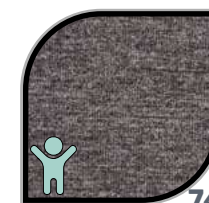

Marengo

74



# LEGGINS LARGO LYON

## Ref. 177



### DESCRIPCIÓN

Leggins largo con cintura elástica y costuras laterales. Diseño anatómico y tejido suave.

### TEJIDO

Punto liso de algodón peinado

### COMPOSICIÓN

92% algodón 8% spandex  
240 gr/m<sup>2</sup>

### OPCIONES DE PERSONALIZACIÓN

- Bordado
- Serigrafía
- Vinilo termoadhesivo



	4/5	6/7	8/9	10/11
A	22	24	26	28
B	60	68	76	84

	XS	S	M	L	XL	XXL
A	30	32	34	36	38	40
B	95	96	97	98	99	100



MUJER



# SUDADERA BÁSICA ALTA VISIBILIDAD

Ref. 032



## DESCRIPCIÓN

Sudadera de corte clásico de cuello redondo con dos bandas reflectantes en pecho, espalda y mangas. Costuras reforzadas en hombros y sisa, así como doble pespunte en cuellos, puños y cintura.

## TEJIDO

Felpa lisa perchada

## COMPOSICIÓN

50% algodón 50% poliéster  
285 gr/m<sup>2</sup>

## OPCIONES DE PERSONALIZACIÓN

- Bordado
- Serigrafía
- Vinilo termoadhesivo

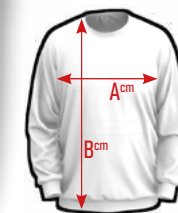

MEDIDAS APROXIMADAS



	S	M	L	XL	XXL
A	53	57	61	65	69
B	71	74	77	80	83



Marino

01

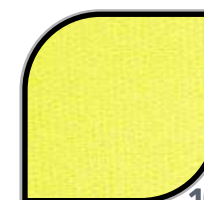

Amarillo Flúor

10

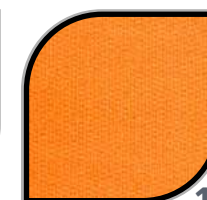

Naranja Flúor

11

# SUDADERA ORIGINAL ALTA VISIBILIDAD

Ref. 033



## DESCRIPCIÓN

Sudadera de corte clásico de cuello alto y media cremallera con dos bandas reflectantes en pecho, espalda y mangas. Costuras reforzadas en hombros y sisa, así como doble pespunte en puños y cintura.

## TEJIDO

Felpa lisa perchada

## COMPOSICIÓN

50% algodón 50% poliéster  
285 gr/m<sup>2</sup>

## OPCIONES DE PERSONALIZACIÓN

- Bordado
- Serigrafía
- Vinilo termoadhesivo

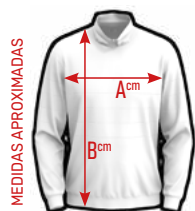

MEIDAS APROXIMADAS



	S	M	L	XL	XXL
A	53	57	61	65	69
B	71	74	77	80	83

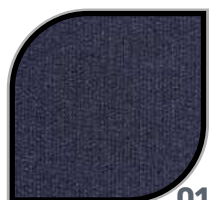

Marino

01

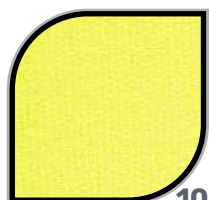

Amarillo Flúor

10



Naranja Flúor

11





# PANTALÓN SPANDEX MULTIBOLSILLOS Ref. 143



## DESCRIPCIÓN

Pantalón sarga con culera, cintura con trevillas y elástico para mejor ajuste. Dos bolsillos fuelle con cierre de velcro en laterales, dos bolsillos parche con cierre de velcro en culera y dos bolsillos costados.

## TEJIDO

Sarga

## COMPOSICIÓN

65% poliéster 35% algodón 2% elastano  
250 gr/m<sup>2</sup>

## OPCIONES DE PERSONALIZACIÓN

- Bordado
- Serigrafía
- Vinilo termoadhesivo

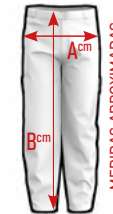

MEDIDAS APROXIMADAS



	XS	S	M	L	XL	XXL
A	33/38	37/43	40/46	44/51	48/55	52/59
B	108	109	110	111	112	113



Marino

01

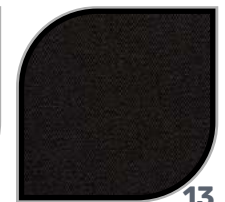

Negro

13

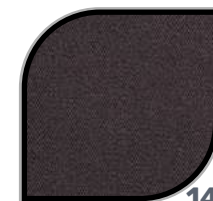

Plomo

14

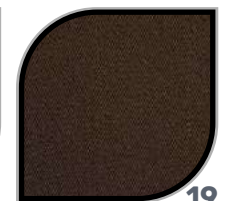

Verde Caza

19

# BOLSO MULTIDEPORTE CUADRADO

## Ref. B001



### DESCRIPCIÓN

Bolso cuadrado multideporte con zapatillero independiente rígido. Bolsillo lateral.

### COMPOSICIÓN

Poliéster 600D

### OPCIONES DE PERSONALIZACIÓN

- Bordado
- Serigrafía
- Vinilo termoadhesivo

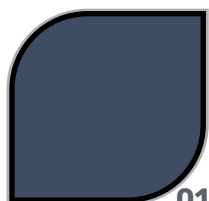

Marino

01



Rojo

05



Negro

13



Náutico

15



Verde Billar

71



Base rígida incluida.

# BOLSO MULTIDEPORTE RECTANGULAR Ref. B002



## DESCRIPCIÓN

Bolso rectangular multideporte con dos bolsillos laterales independientes.

## COMPOSICIÓN

Poliéster 600D

## OPCIONES DE PERSONALIZACIÓN

- Bordado
- Serigrafía
- Vinilo termoadhesivo

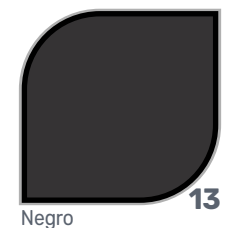
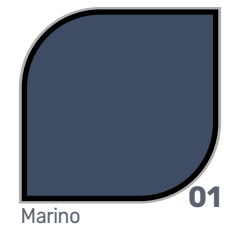
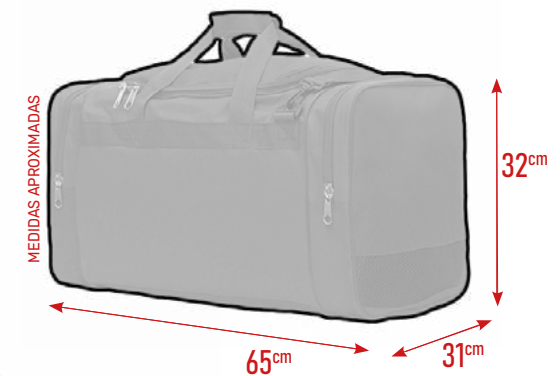

Marino

01

Negro

13

# MOCHILA MULTIDEPORTE ZAPATILLERO Ref. B003



## DESCRIPCIÓN

Mochila multideporte con zapatillero independiente rígido. Bolsillo frontal e interior.

## COMPOSICIÓN

Poliéster 600D

## OPCIONES DE PERSONALIZACIÓN

- Bordado
- Serigrafía
- Vinilo termoadhesivo

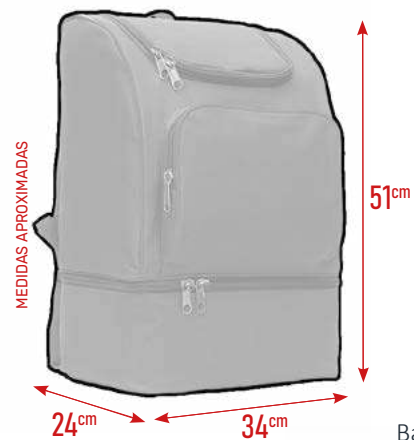

Base rígida incluida.



Marino

01

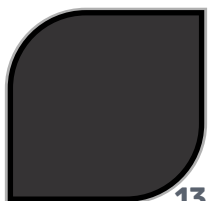

Negro

13



Náutico

15



# MOCHILA MULTIDEPORTE NEW Ref. B004



## DESCRIPCIÓN

Mochila multideporte. Bolsillo frontal, interior y lateral.

## COMPOSICIÓN

Poliéster 600D

## OPCIONES DE PERSONALIZACIÓN

- Bordado
- Serigrafía
- Vinilo termoadhesivo

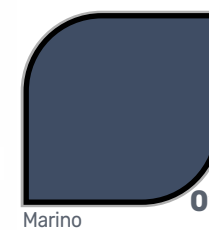
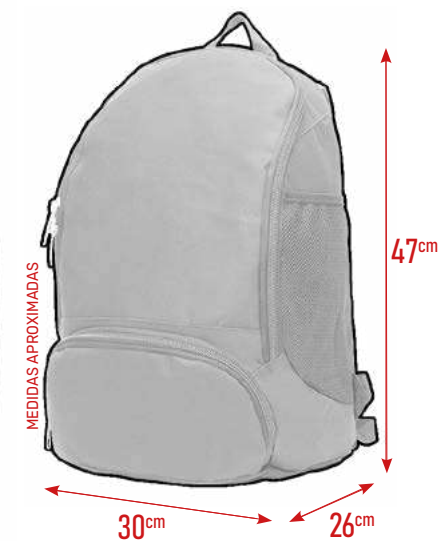

Marino

01



Negro

13



# BOLSA GYM Ref. B005

## DESCRIPCIÓN

Bolsa con cierre de cordón.

## COMPOSICIÓN

Poliéster 600D + 210 AC

## OPCIONES DE PERSONALIZACIÓN

- Bordado
- Serigrafía
- Vinilo termoadhesivo

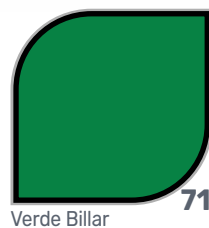
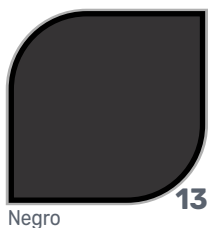
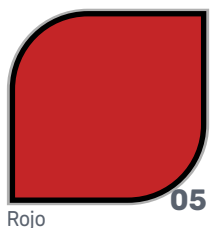
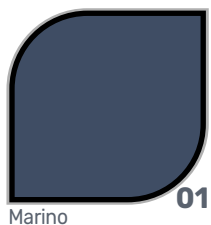

# ZAPATILLERO Ref. B006

## DESCRIPCIÓN

Bolsa zapatillero con ojeteros para aireación.

## COMPOSICIÓN

Poliéster 600D

## OPCIONES DE PERSONALIZACIÓN

- Bordado
- Serigrafía
- Vinilo termoadhesivo

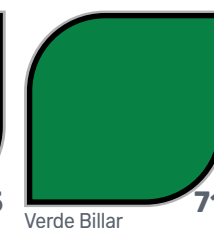
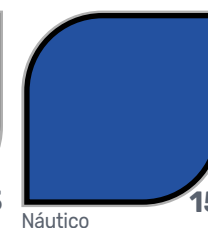
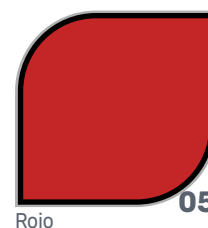
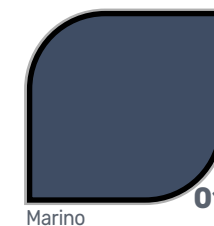
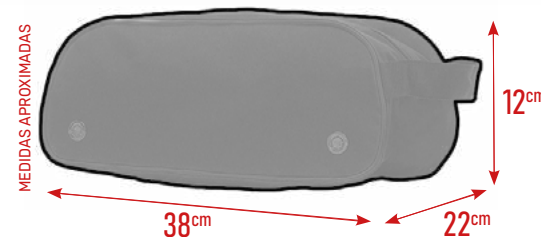



# LONAS PUBLICITARIAS

Ref. 209

## TEJIDO

Lona blanca mate 510 gr  
Ojales de plástico  
de 16 mm cada 50 cm



137 cm - medida máxima



25 metros - medida máxima

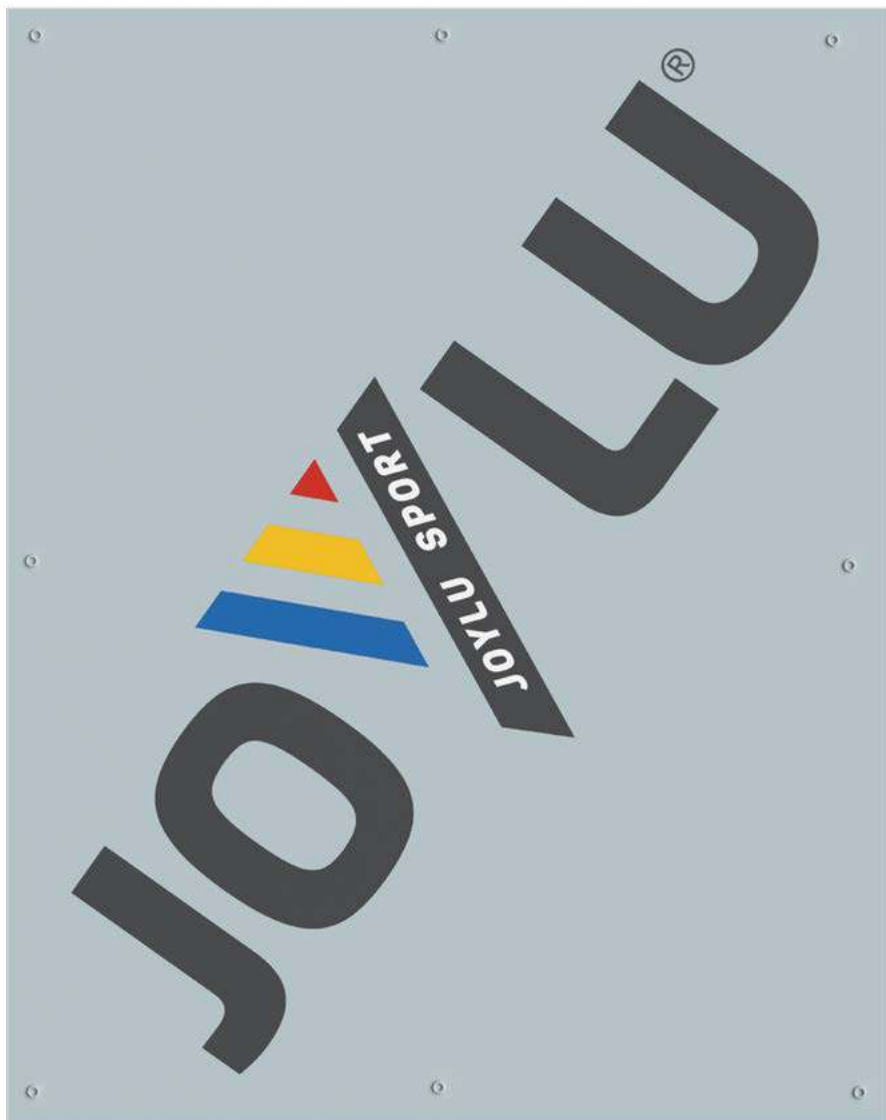

MODELO VERTICAL



MODELOS HORIZONTAL



[www.joylu.com](http://www.joylu.com)

Empresa española fabricante de textil y confección deportiva,  
con una amplia gama de productos y acabados con opciones personalizables:  
sublimación, serigrafía, bordado, etc.

## JOYLU SPORT S.L.

[www.joylu.com](http://www.joylu.com)

957.324.542

[info@joylu.com](mailto:info@joylu.com)

[pedidos@joylu.com](mailto:pedidos@joylu.com)

C/ IMPRENTA DE LA ALBORADA, 119F  
(POLÍGONO INDUSTRIAL LAS QUEMADAS)  
14014 - CÓRDOBA  
(ESPAÑA)

Horario:



Lunes a jueves: 09:00 a 18:00 (continuo)

Viernes: 07:30 a 15:00

Julio y agosto:

Lunes a viernes: 07:30 a 15:00



 [facebook.com/JoyluSport](https://facebook.com/JoyluSport)  
 [instagram.com/joylu\\_sport/](https://instagram.com/joylu_sport/)  
 [mobile.twitter.com/joylu\\_sport](https://mobile.twitter.com/joylu_sport)

Consulte con nuestro departamento comercial las distintas opciones en tejidos, patrones, acabados, y cualquier duda que tenga  
Las imágenes de este catálogo están realizadas digitalmente en 3D, pueden no coincidir puntualmente con el modelo original